

B-DES5/2-100

B-DES5/2-120

K ..... / S .....



B-DES5/2  
SZUF-KF1

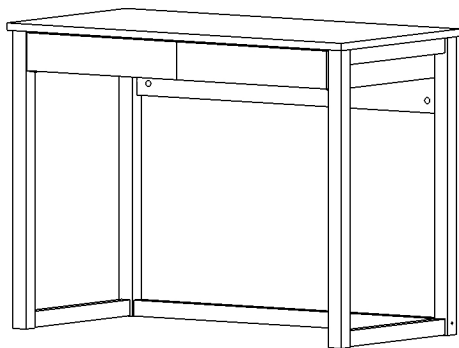



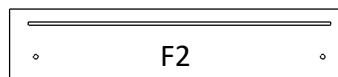
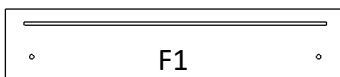
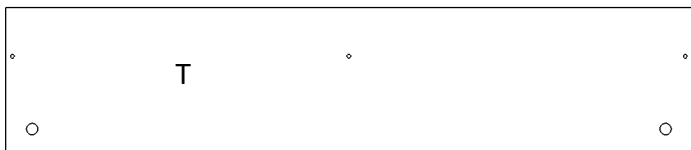
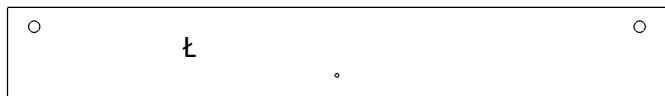
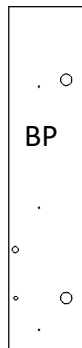
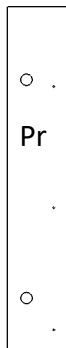
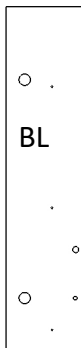
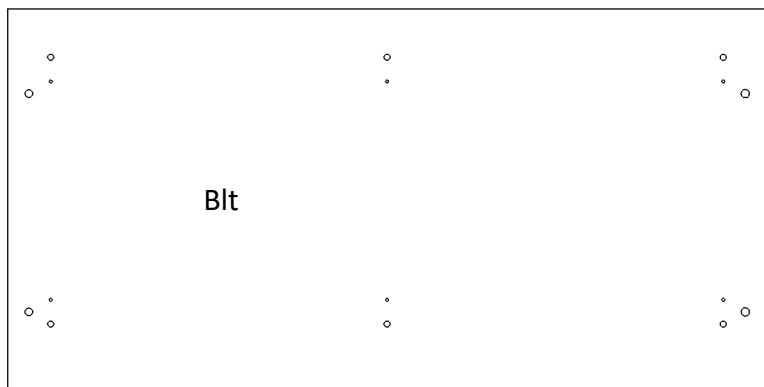



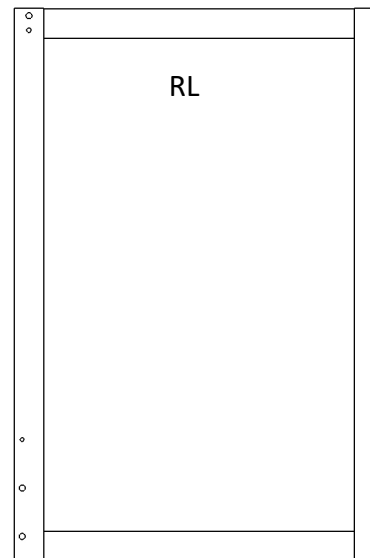
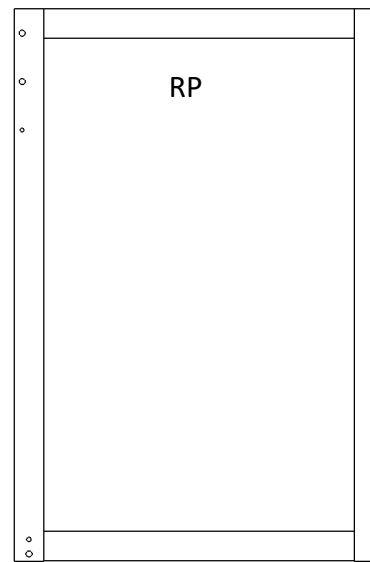





wer. 1.2022



Be



-  K
-  KF1
-  MT1
-  M1
-  ZB
-  S1
-  KL4
-  G
-  i8  
7x80mm
-  i5  
6x50mm
-  PR  
400mm - 100  
450mm - 120
-  W  
3x12mm  
3x16mm  
12mm, 16mm

0

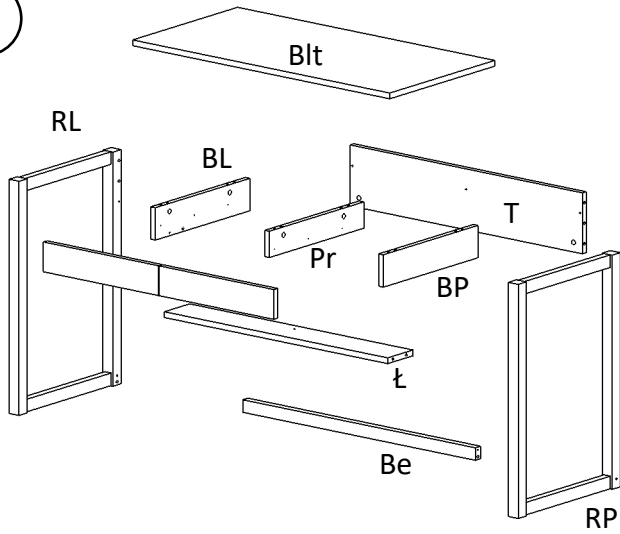

1

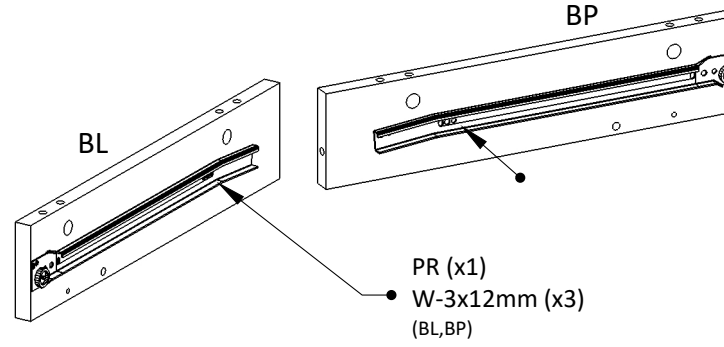

2

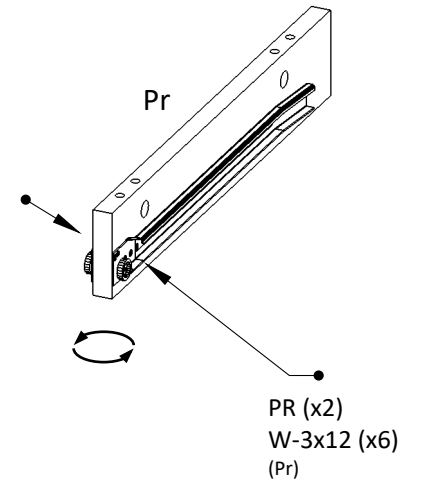

3

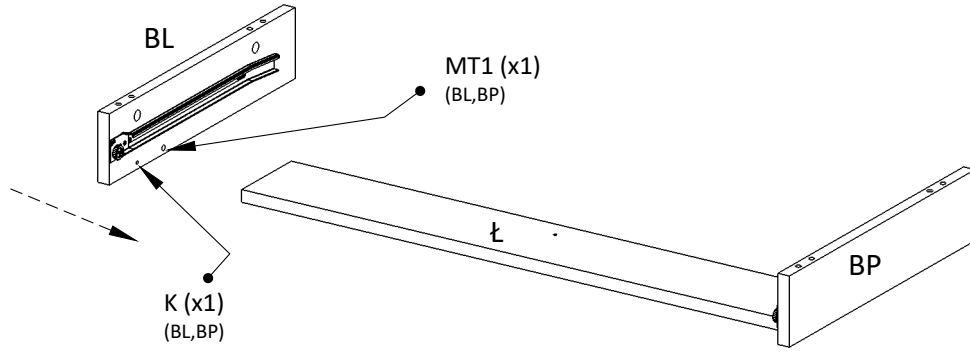

4

